

Article number: 12713000025120

Description: KLEE-coil 713 000 025.120

M2,5 Unhardened, zinc-pl. & chr. yellow

Measures

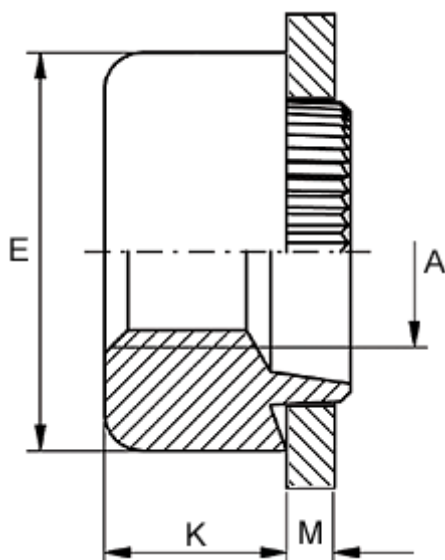

Female thread A	= M2,5
Height K	= 3.0
Outer diameter E	= 8.0
Plate thickness	= 3.5 to 3.7
Recommended bore diameter for extreme load	= 6.0
Recommended bore diameter for normal use	= 6.0